

BLACKMER PARTS LIST

PUMP MODELS: LGRL1.25, LGL1.25, LGL1.5 LGRLF1.25A, LGLF1.25A, LGLF1.5A

Keep with Instructions 501-B00 for Installation, Operation and Maintenance

960410 **PARTS LIST**
Page 1 of 3 **501-B01**

Section 501
Effective Jun 2014
Replaces Apr 2013

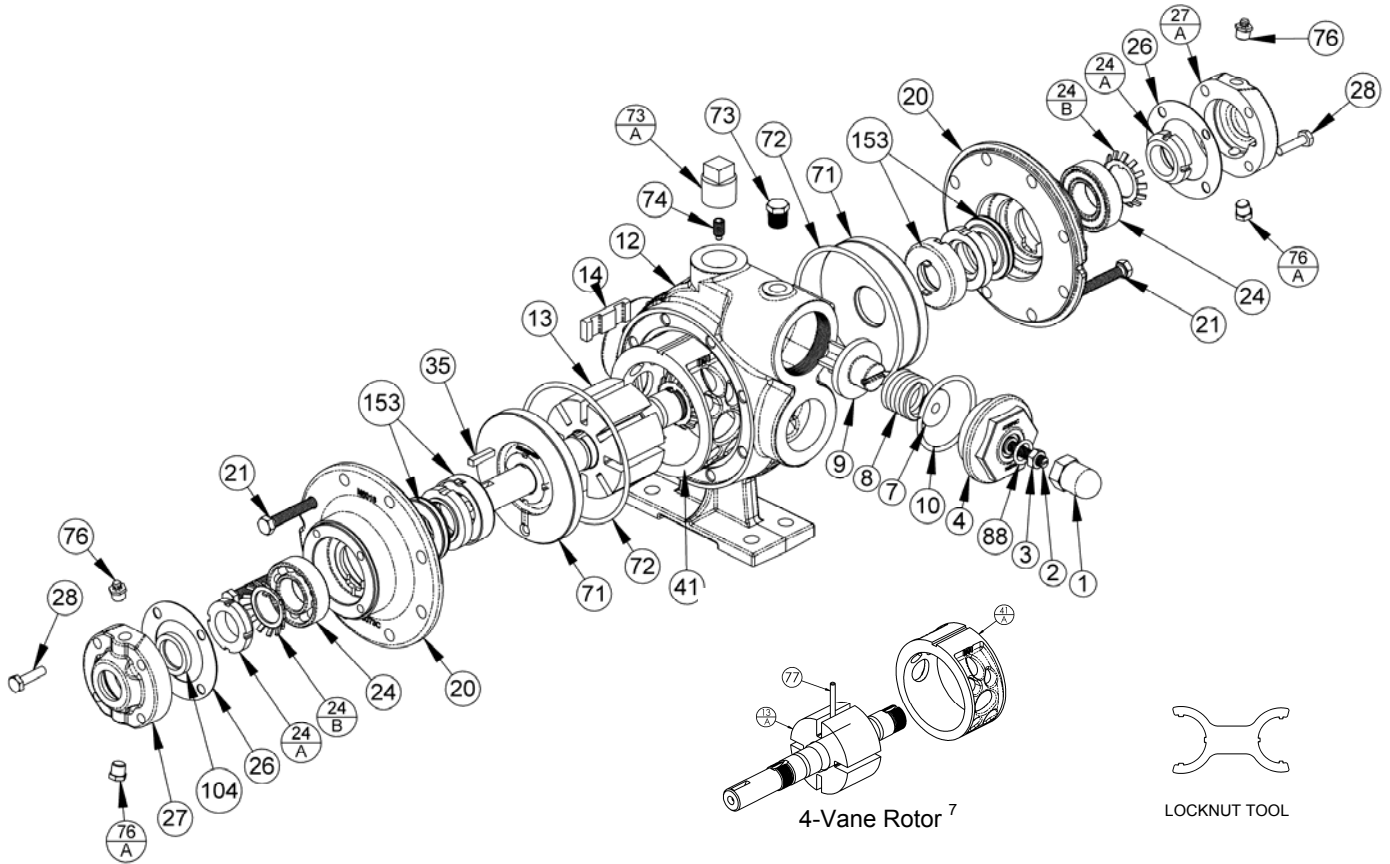

Ref. No.	Description	Parts per Pump	Part No.	Ref. No.	Description	Parts per Pump	Part No.
1	Cap – Relief Valve (R/V)	1	413200	27A	Bearing Cover – Outboard	1	043071
2	Adjusting Screw – R/V	1	433909	28	Capscrews – Bearing Cover	8	920080
3	Locknut – Adjusting Screw	1	922923	35	Shaft Key ⁸	1	¹ 909152
4	Cover – R/V	1	413076	41	Liner – LGRL(F)1.25 [8 - Vane Only]	1	² 183019
7	Spring Guide – R/V	1	423955		Liner – LGL(F)1.25 [8 - Vane Only]		² 183020
8	Spring – R/V (81 – 150 psi)	1	471428		Liner – LGL(F)1.5 [8 - Vane Only]		² 183310
9	Valve - R/V	1	453077	71	Disc	2	¹ 063075
10	O-Ring – R/V Cover	1	¹ 711924	72	O-Ring – Head	2	¹ 701918
12	Casing with feet (1.25)	1	013075	73	Gage Plug (1/4")	1	908198
	Casing with feet (1.5)		013376	73A	Gage Plug (3/4")	1	⁶ 908225
13	Rotor & Shaft Assembly, Eight Vane (with Ref. Nos. 24A & 24B)	1	² 262300	74	Setscrew – Liner	1	922088
14	Vane – Duravane	8	¹ 093088	76	Grease Fitting	2	317815
20	Head	2	033073	76A	Grease Relief Fitting	2	701992
21	Capscrews – Head	16	920276	88	O-Ring – R/V Cap	1	¹ 701949
24	Ball Bearing	2	¹ 903114	104	Grease Seal	1	¹ 331927
24A	Locknut – Bearing	2	² 903534	—	Tool - Locknut	—	903090
24B	Lockwasher – Bearing	2	¹ 903533	—	Kit - Maintenance [8 Vane]	—	898976
26	Gasket - Bearing Cover	2	¹ 383075	—	Kit - Rebuild LGRL(F)1.25(A) [8 Vane]	—	899076
27	Bearing Cover – Inboard	0-1	043070	—	Kit - Rebuild LGL(F)1.25(A) [8 Vane]	—	899077
				—	Kit - Rebuild LGL(F)1.5(A) [8 Vane]	—	899078

¹ Included in Maintenance Kits and Rebuild Kits ² Included in Rebuild Kits.

⁶ Ref. No. 73A: Older pumps may use a 1/4" plug (pn 908198) or 1/2" plug (pn 908215).

⁷ See page 4 re parts for older pumps fitted with a 4-vane rotor.

⁸ Ref. No. 35: Early pumps used Woodruff Key 909125

NEMA C-Face Motor Adaptors

Models: LGRLF1.25A, LGLF1.25A, LGLF1.5A

Ref. No.	Description	Parts per Pump	Part No.
12A	Casing without Feet – LG(R)LF1.25	1	013077
	Casing without Feet – LGLF1.5		013377
26	Gasket - Bearing Cover	1	383075
28A	Motor Adaptor Mounting Screws	4	920101
28C	Guard Screw	1	920026
34	Coupling Half – Pump	1	906147
	Coupling Spider		906155
	Coupling Half – Motor (56C)		906151
	Coupling Half – Motor (143TC,145TC,184C)		906147
	Coupling Half – Motor (182TC,184TC,215C)		906146
56	Capscrews – Adapter Ring Mounting	4	920480
76	Grease Fitting	1	317815
76A	Grease Relief Fitting	1	701992
86	Motor Adapter Ring - 182TC,184TC,215C	1	832914
104	Grease Seal	1	331927
108	Motor Adaptor – Unfooted	1	832912
	Motor Adaptor – Footed (Both include Ref. 76 & 76A)		833000
108B	Capscrews - Motor Adaptor	4	920331
186	Guard	1	804120

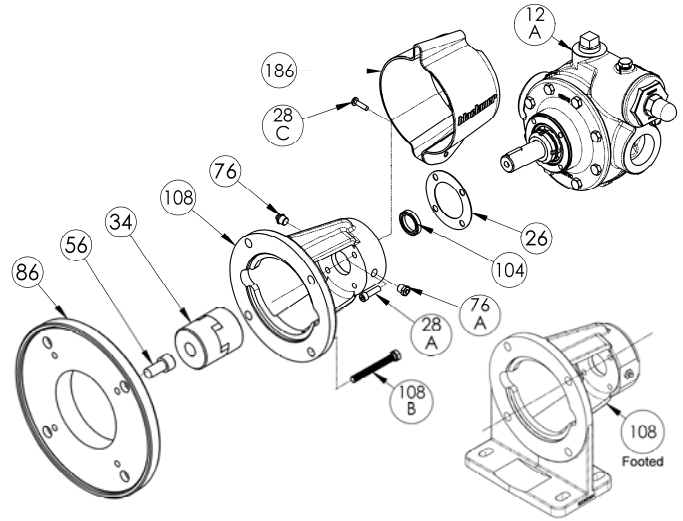

IEC Flanged Face Motor Adaptor

Models: LGRLF1.25A, LGLF1.25A, LGLF1.5A

Ref. No.	Description	Parts per Pump	Part No.
26	Gasket - Bearing Cover	1	383075
28A	Motor Adaptor Mounting Screws	4	920101
28C	Guard Screw	2	920026
34	Coupling Half – Pump (for IEC100/112)	1	906182
	Coupling Spider (for IEC100/112)		906178
	Coupling Half – Motor (IEC100/112)		906180
76	Grease Fitting	1	317815
76A	Grease Relief Fitting	1	701992
76B	Extension Coupling	2	701905
104	Grease Seal	1	331927
108B	Capscrew – Motor Adaptor to Motor	4	920044
108C	Motor Adaptor (IEC 100/112 B14A) Includes Ref. Nos. 76, 76A & 76B	1	832930
108D	Washer	4	792094
186C	Guard Half	2	804198

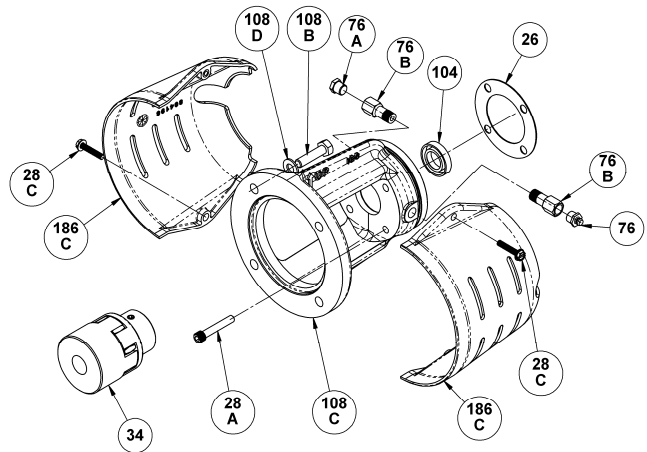

1809 Century Avenue, Grand Rapids, Michigan 49503-1530, U.S.A.

Telephone: (616) 241-1611 / Fax: (616) 241-3752

E-Mail: blackmer@blackmer.com / Internet: www.blackmer.com

Parts List 501-B01

Page 2 of 3

MECHANICAL SEAL

Ref. No.	Part Name	Parts Per Pump	Part No.
153	Mechanical Seal Assembly	2	¹ 333045
153A	Stationary Seat (Hardened Steel)	2	**
153B	Seal Face (Carbon)	2	**
153C	Jacket Assembly	2	**
153D	O-Ring – Stationary (Buna-N)	2	711916
153E	O-Ring – Rotating (Buna-N)	2	711915

¹ Included in Maintenance Kits and Rebuild Kits

** Not available as separate replacement parts.

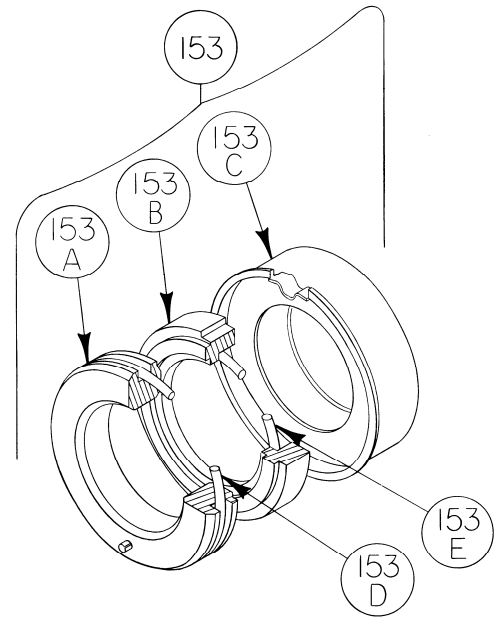

4-VANE ROTOR/SHAFT PARTS

Ref. No.	Part Name	Parts Per Pump	Part No.
13A	Rotor & Shaft Assembly, Four Vane (Includes Ref. Nos. 24A & 24B)	1	² 263076
14	Vane – Duravane	4	¹ 093088
41A	Liner – LGRL(F)1.25 [4 - Vane Only]	1	² 183003
	Liner – LGL(F)1.25 [4 - Vane Only]		² 183004
	Liner – LGL(F)1.5 [4 - Vane Only]		² 183301
77	Push Rod – LGRL(F)1.25	2	¹ 123004
	Push Rod – LGL(F)1.25		¹ 123076
	Push Rod LGL(F)1.5		¹ 123401

Part Name	Part No.
Kit – Maint LGRL(F)1.25A [4 Vane]	898917
Kit - Maint LGL(F)1.25(A) [4 Vane]	898918
Kit - Maint LGL(F)1.5(A) [4 Vane]	898919
Kit - Rebuild LGRL(F)1.25A [4 Vane]	899017
Kit - Rebuild LGL(F)1.25(A) [4 Vane]	899018
Kit - Rebuild LGL(F)1.5(A) [4 Vane]	899019



1809 Century Avenue, Grand Rapids, Michigan 49503-1530, U.S.A.

Telephone: (616) 241-1611 / Fax: (616) 241-3752

E-Mail: blackmer@blackmer.com / Internet: www.blackmer.com

Parts List 501-B01

Page 3 of 3