

# BLACKMER POWER PUMPS

## INSTALLATION OPERATION AND MAINTENANCE INSTRUCTIONS

**MODELS: LGRL1.25, LGRLF1.25A, LGL1.25,  
LGLF1.25A, LGL1.5, LGLF1.5A  
Discontinued Models: LGRLF1.25, LGLF1.25**

960409

**INSTRUCTIONS NO. 501-B00**

Section Effective Replaces	501 Aug 2014 Jan 2014
----------------------------	-----------------------------

Patent Protected by U.S. Patent 6030191 and Related Foreign Patents.



### SAFETY DATA



#### This is a SAFETY ALERT SYMBOL.

When you see this symbol on the product, or in the manual, look for one of the following signal words and be alert to the potential for personal injury, death or major property damage



Warns of hazards that WILL cause serious personal injury, death or major property damage.



Warns of hazards that CAN cause serious personal injury, death or major property damage.



Warns of hazards that CAN cause personal injury or property damage.

#### NOTICE:

Indicates special instructions which are very important and must be followed.

#### NOTICE:

Blackmer liquefied gas pumps MUST only be installed in systems which have been designed by qualified engineering personnel. The system MUST conform to all applicable local and national regulations and safety standards.

This manual is intended to assist in the installation and operation of the Blackmer liquefied gas pumps, and MUST be kept with the pump.

Blackmer liquefied gas pump service shall be performed by qualified technicians ONLY. Service shall conform to all applicable local and national regulations and safety standards.

Thoroughly review this manual, all Instructions and hazard warnings, BEFORE performing any work on the Blackmer liquefied gas pumps.

Maintain ALL system and Blackmer liquefied gas pump operation and hazard warning decals.

### TABLE OF CONTENTS

Page

#### PUMP DATA

Technical Data .....	2
Initial Pump Start Up Information.....	2

#### INSTALLATION

Pre-Installation Cleaning .....	3
Location and Piping.....	3
Pump Relief Valve and Bypass valve.....	3
Check Valves .....	4
Mounting .....	4
Motor Adaptors.....	4
Coupling Alignment .....	4
Pump Rotation.....	4
To Change Pump Rotation.....	4

#### OPERATION

Pre-Start Up Check List.....	5
Start Up Procedures.....	5
Relief Valve Setting and Adjustment .....	5

#### MAINTENANCE

Strainers.....	6
Lubrication.....	6
Vane Replacement.....	7
Pump Disassembly .....	7
Parts Replacement.....	7
Pump Assembly .....	8

#### TROUBLE SHOOTING .....

Numbers in parentheses following individual parts indicate reference numbers on Blackmer Parts List No. 501-B01.

Blackmer pump manuals and parts lists may be obtained from Blackmer's website ([www.blackmer.com](http://www.blackmer.com)) or by contacting Blackmer Customer Service.

## SAFETY DATA

**⚠ WARNING**



Hazardous machinery can cause serious personal injury.

**Failure to disconnect and lockout electrical power or engine drive before attempting maintenance can cause severe personal injury or death**

**⚠ WARNING**



Hazardous voltage. Can shock, burn or cause death.

**Failure to disconnect and lockout electrical power before attempting maintenance can cause shock, burns or death**

**⚠ WARNING**



Hazardous pressure can cause serious personal injury or property damage

**Disconnecting fluid or pressure containment components during pump operation can cause serious personal injury or property damage.**

**⚠ WARNING**



Hazardous pressure can cause serious personal injury or property damage

**Failure to relieve system pressure prior to performing pump service can cause serious personal injury or property damage. Systems with meters will still be pressurized even after the hose is emptied**

**⚠ WARNING**



Hazardous or toxic fluids can cause serious injury.

**If pumping hazardous or toxic fluids, system must be flushed and decontaminated, inside and out, prior to performing service or maintenance**

**⚠ WARNING**



Do not operate without guard in place

**Operation without guards in place can cause serious personal injury, major property damage, or death.**

## PUMP DATA

### PUMP IDENTIFICATION

A pump Identification tag, containing the pump serial number, I.D. number, and model designation, is attached to each pump. It is recommended that the data from this tag be recorded and filed for future reference. If replacement parts are needed, or if information pertaining to the pump is required, this data must be furnished to a Blackmer representative.

#### TECHNICAL DATA

Maximum Pump Speed	1,750 RPM
Maximum Operating Temperature	240°F (115°C)
Maximum Differential Pressure	125 psi (8.62 Bar)
Maximum Working Pressure	350 psi (24.1 Bar)

- Technical Data is for standard materials of construction. Consult Blackmer Material Specs for optional materials of construction.
- These pumps are listed by Underwriters' Laboratories for liquefied petroleum gas and NH<sub>3</sub> service.

#### INITIAL PUMP START UP INFORMATION

Model No.:	_____
Serial No.:	_____
ID No.:	_____
Date of Installation:	_____
Inlet Gauge Reading:	_____
Discharge Gauge Reading:	_____
Flow Rate:	_____

# INSTALLATION

## NOTICE:

Blackmer pumps must only be installed in systems designed by qualified engineering personnel. System design must conform with all applicable regulations and codes and provide warning of all system hazards.

## NOTICE:

This pump shall be installed in accordance with the requirements of NFPA 58 all applicable local, state and national regulations.



- ⚠ Install, ground and wire to local and National Electrical Code requirements.
- ⚠ Install an all-leg disconnect switch near the unit motor.
- ⚠ Disconnect and lockout electrical power before installation or service
- ⚠ Electrical supply **MUST** match motor nameplate specifications.

⚠ Motors equipped with thermal protection automatically disconnect motor electrical circuit when overload exists. Motor can start unexpectedly and without warning.

## PRE-INSTALLATION CLEANING

### NOTICE:

New pumps contain residual test fluid and rust inhibitor. If necessary, flush pump prior to use.

Foreign matter entering the pump WILL cause extensive damage. The supply tank and intake piping MUST be cleaned and flushed prior to pump installation and operation.

## LOCATION AND PIPING

Pump life and performance will be significantly reduced when installed in an improperly designed system. Before starting the layout and installation of the piping system, review the following suggestions:

1. Locate the pump as near as possible to the source of supply to avoid excessive inlet pipe friction.
2. The inlet line should be at least as large as the intake port on the pump. It should slope downward to the pump, and should not contain any upward loops. Eliminate restrictions such as sharp bends; globe valves, unnecessary elbows, and undersized strainers.
3. A strainer must be installed in the inlet line to protect the pump from foreign matter. The strainer should be located at least 24" (0.6m) from the pump, and have a net open area of at least four times the area of the intake piping. Strainers must be cleaned regularly to avoid pump starvation.
4. The intake and discharge piping system must be free of all leaks.
5. Expansion joints, placed at least 36" (0.9m) from the pump, will compensate for expansion and contraction of the pipes. Contact the flexible connector/hose manufacturer for required maintenance/care and design assistance in their use.

6. Install pressure gauges in the NPT ports provided in the pump casing to check pump performance at start up.
7. ALL piping and fittings MUST be properly supported to prevent any piping loads from being placed on the pump.
8. Check alignment of pipes to pump to avoid strains which might later cause misalignment. See Figure 2. Unbolt flanges or break union joints. Pipes should not spring away or drop down. After pump has been in operation for a week or two, completely recheck alignment.

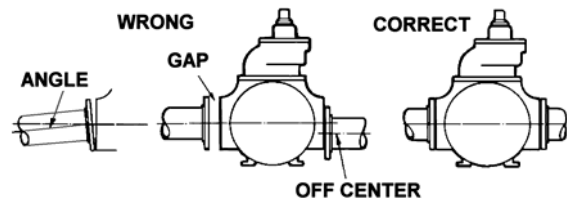

Figure 2

9. The use of a vapor return line will speed up delivery by preventing pressure build up at the receiving tank and pressure reduction in the supply tank.
10. Keeping the liquefied gas systems full of liquid, even when idle, will keep the O-rings from changing shape, shrinking or super cooling. Evaporation of liquefied gas leaves an abrasive powder on the surface which can cause wear to the pump, meter, and seals.

## INTERNAL PUMP RELIEF VALVE AND EXTERNAL BYPASS VALVE

### NOTICE:

The pump internal relief valve is designed to protect the pump from excessive pressure and must not be used as a system pressure control valve.

For ALL liquefied gas applications, install an external bypass valve, and any necessary piping, back to the tank. DO NOT pipe the bypass valve back to the intake line.

Refer to "Relief Valve Setting & Adjustment" section. The setting on the external bypass valve must be at least 25 psi (1.7 bar) lower than the pump internal relief valve setting. The valve and piping must be of adequate size to accommodate the full flow from the pump when the discharge line is closed.

Refer to Blackmer Bypass Valve Installation and Maintenance Instructions for bypass valve settings and adjustments.

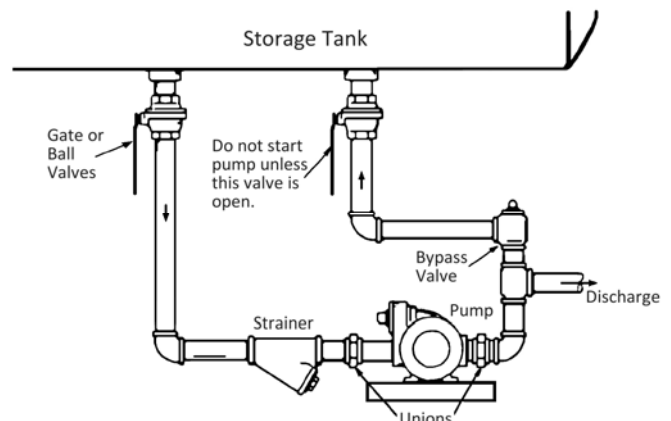

Figure 3 – Bypass Valve Mounting

# INSTALLATION

## CHECK VALVES

The use of check valves or foot valves in the supply tank is not recommended with self-priming, positive displacement pumps.

If the possibility of liquid backflow exists when the pump is off, a check valve in the pump discharge piping is recommended because the pump can motor in the reverse rotation and create undue stress on all attached components. Never start a pump when it is rotating in the reverse rotation as the added starting torque can damage the pump and related equipment.

## PUMP MOUNTING

A solid foundation reduces noise and vibration, and will improve pump performance. On permanent installations it is recommended the pumping unit be secured by anchor bolts as shown in Figure 4. This arrangement allows for slight shifting of position to accommodate alignment with the mounting holes in the base plate.

For new foundations, it is suggested that the anchor bolts be set in concrete. When pumps are to be located on existing concrete floors, holes should be drilled into the concrete to hold the anchor bolts.

When installing units built on channel or structural steel type bases, use care to avoid twisting the base out of shape when anchor bolts are tightened. Shims should be used under the edges of the base prior to tightening of the anchor bolts to prevent distortion.

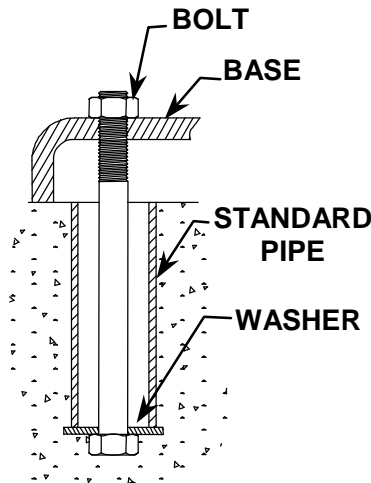

Figure 4 – Pipe Type Anchor Bolt

## MOTOR ADAPTORS

'LGLF' and 'LGRLF' models are fitted with a motor adaptor to provide direct mounting to flange faced motors. NEMA motor adaptors are available in unfooted and footed styles for a range of motor sizes. IEC motor adaptors are unfooted.

Unfooted motor adaptors require footed motors. Footed motor adaptors should be used with unfooted motors when available. If a footed motor is used, the motor must not be secured to baseplate.

## COUPLING ALIGNMENT

The pump must be directly coupled to a gear reducer and/or driver with a flexible coupling. Verify coupling alignment after installation of new or rebuilt pumps. Both angular and parallel coupling alignment MUST be maintained between the pump, gear, motor, etc. in accordance with manufacturer's instructions. See Figure 5.

1. Parallel alignment: The use of a laser alignment tool or dial indicator is preferred. If a laser alignment tool or dial indicator is not available, use a straightedge. Turn both shafts by hand, checking the reading through one complete revolution. Maximum offset should be less than .0005" (0.127 mm).
2. Angular alignment: Insert a feeler gauge between the coupling halves. Check the spacing at 90° increments around the coupling (four checkpoints). Maximum variation should not exceed 0.005" (0.127 mm). Some laser alignment tools will check angular alignment as well.
3. Replace the coupling guards after setting alignment.

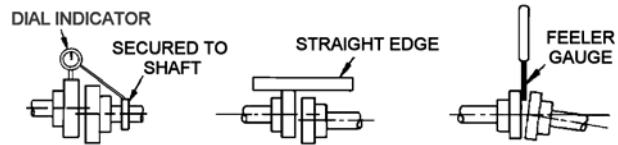
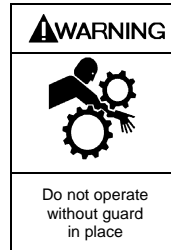

Figure 5 – Coupling Alignment



Operation without guards in place can cause serious personal injury, major property damage, or death.

Do not operate without guard in place

## PUMP ROTATION

### NOTICE:

Confirm correct pump rotation by checking the pump rotation arrows respective to pump driver rotation.

## TO CHANGE PUMP ROTATION

To reverse rotation, the pump must be disassembled then reassembled with the shaft on the opposite side of the pump. See the 'Maintenance' section for instructions.

# OPERATION

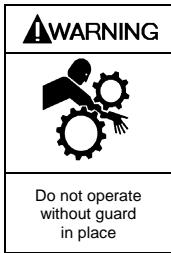

**Operation without guards in place can cause serious personal injury, major property damage, or death.**

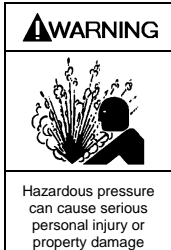

**Failure to relieve system pressure prior to performing pump service can cause serious personal injury or property damage. Systems with meters will still be pressurized even after the hose is emptied**

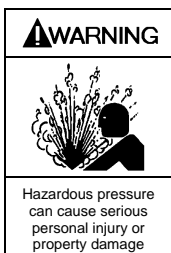

**Disconnecting fluid or pressure containment components during pump operation can cause serious personal injury or property damage.**

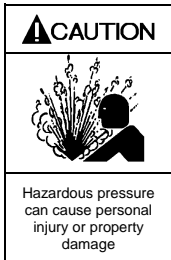

**Pumps operating against a closed valve can cause system failure, personal injury and property damage**

## PRE-START UP CHECK LIST

1. Check the alignment of the pipes to the pump. Pipes should be supported so that they do not spring away or drop down when pump flanges or union joints are disconnected.
2. Verify proper coupling alignment.
3. Check the entire pumping system to verify that the proper inlet and discharge valves are fully open, and that the drain valves and other auxiliary valves are closed.
4. Install suction and discharge pressure gauges on the pump in the threaded connections provided. These can be used to check actual suction and discharge conditions after pump start-up.
5. Check the wiring of the motor.
6. Briefly start the pump to verify proper rotation direction.

## START UP PROCEDURES

### NOTICE:

**Consult the "General Pump Troubleshooting" section of this manual if difficulties during start up are experienced.**

1. SLOWLY build pressure in the pump.
2. Start the pump. Priming should occur within one minute.

3. Check the suction and discharge pressure gauges to see if the pump is operating within the expected conditions.
4. Check for leakage from the piping and equipment.
5. Check for excessive noise, vibration or overheating of the pump, reducer, and motor.
6. If possible, check the flow rate.
7. Close the discharge valve and check the differential pressure across the pump. Pressure must not exceed the pressure setting of the external bypass valve.
8. With the discharge valve still closed, momentarily close the manual shut-off valve in the bypass return line to check the pump relief valve. The pressure should be at least 25 psi (1.7 bar) higher than the maximum system operating pressure or the system pressure control valve setting. If adjustments need to be made, refer to "Relief Valve Setting and Adjustment" section of this manual.
9. The external bypass valve must be set at least 25 psi (1.7 bar) lower than the internal pump relief valve. NOTE: The normal operating pressure must be at least 5 - 15 psi (0.3 - 1.0 bar) less than the external bypass valve setting. Pump speeds which result in higher pressures (nearing the valve setting) forces the liquid to recirculate, creating excessive wear on the pump and equipment.

## RELIEF VALVE SETTING AND ADJUSTMENT

The relief valve pressure setting is marked on a metal tag attached to the valve cover. Generally, the relief valve should be set at least 15 - 20 psi (1.0 - 1.4 Bar) higher than the operating pressure, or the external bypass valve setting.

**DO NOT remove the R /V Cap OR adjust the relief valve pressure setting while the pump is in operation.**

1. **To INCREASE the pressure setting**, remove the relief valve cap, loosen the locknut, and turn the adjusting screw *inward*, or clockwise. Replace the valve cap.
2. **To DECREASE the pressure setting**, remove the relief valve cap, loosen the locknut, and turn the adjusting screw *outward*, or counterclockwise. Replace the valve cap.

Refer to the individual Blackmer pump parts lists for various spring pressure ranges.

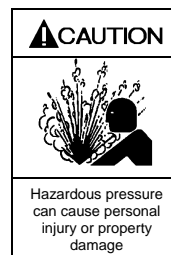

**Incorrect settings of the pressure relief valve can cause pump component failure, personal injury, and property damage.**

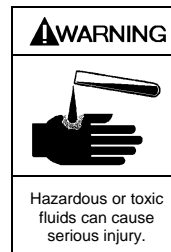

**Relief valve cap is exposed to pumpage and will contain some fluid**

# MAINTENANCE

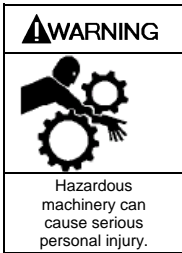

Failure to disconnect and lockout electrical power before attempting maintenance can cause shock, burns or death

Hazardous machinery can cause serious personal injury.

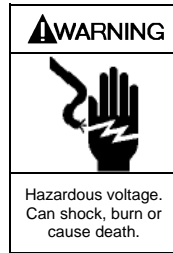

Failure to disconnect and lockout electrical power before attempting maintenance can cause shock, burns or death

Hazardous voltage. Can shock, burn or cause death.

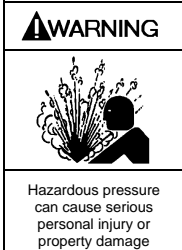

Disconnecting fluid or pressure containment components during pump operation can cause serious personal injury or property damage.

Hazardous pressure can cause serious personal injury or property damage

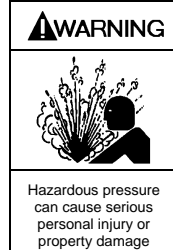

Failure to relieve system pressure prior to performing pump service can cause serious personal injury or property damage. Systems with meters will still be pressurized even after the hose is emptied

Hazardous pressure can cause serious personal injury or property damage

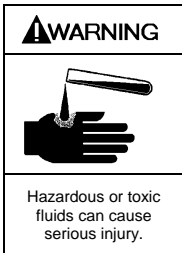

If pumping hazardous or toxic fluids, system must be flushed and decontaminated, inside and out, prior to performing service or maintenance

Hazardous or toxic fluids can cause serious injury.

**NOTICE:**  
Maintenance shall be performed by qualified technicians only. Follow the appropriate procedures and warnings as presented in this manual.

## SCHEDULED MAINTENANCE

### STRAINERS

Strainers must be cleaned regularly to avoid pump starvation. Schedule will depend upon the application and conditions.

### LUBRICATION

**NOTICE:**  
To avoid possible entanglement in moving parts do not lubricate pump bearings, gear reducer or any other parts while the pump is running.

**NOTICE:**  
If pumps are repainted in the field, ensure that the grease relief fittings (76A) are functioning properly after painting. Do NOT paint them closed. Remove any excess paint from the fittings.

Pump bearings should be lubricated every one to twelve weeks (AT MINIMUM), depending on the application, and operating conditions.

#### Recommended Grease:

Mobil® - Mobilgrease XHP222,  
Exxon® - RONNEX MP Grease,  
or equivalent.

#### Greasing Procedure:

1. Remove the grease relief fittings (76A) from the bearing covers (27A).
2. **SLOWLY** apply grease with a hand gun until grease begins to escape from the grease relief fitting port.
3. Replace the grease relief fittings (76A).

DO NOT overgrease pump bearings. While it is normal for some grease to escape from the grease tell-tale hole after lubrication, excessive grease on pumps equipped with mechanical seals can cause seal failure.

# MAINTENANCE

## VANE REPLACEMENT

### NOTICE:

Maintenance shall be performed by qualified technicians only. Follow the appropriate procedures and warnings as presented in manual.

1. Drain and relieve pressure from the pump and system as required.
2. Remove the head assembly from the outboard (non-driven) side of the pump according to steps 4 - 9 in the "Pump Disassembly" section of this manual.
3. Turn the shaft by hand until a vane (14) comes to the top (12 o'clock) position of the rotor. Remove the vane.
4. Install a new vane (14), ensuring that the rounded edge is UP, and the relief grooves are facing towards the direction of rotation. See Figure 6.
5. Repeat steps 3 and 4 until all vanes have been replaced. NOTE: The current rotor & shaft has eight vanes and no push rods. Older rotor & shafts may have four vanes and two push rods.
6. Reassemble the pump according to the "Pump Assembly." section of this manual.

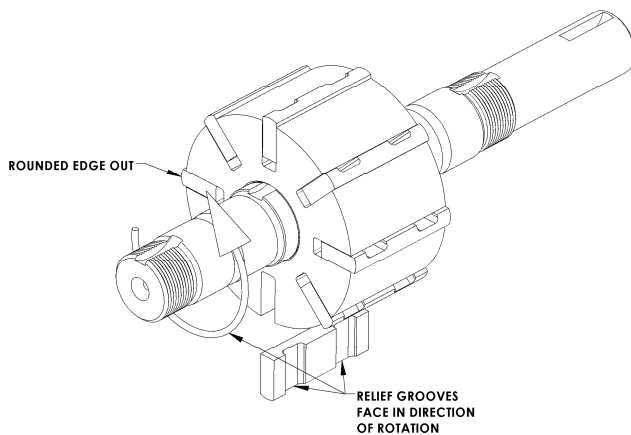

Figure 6 – Vane Replacement

## PUMP DISASSEMBLY

### NOTICE:

Follow all hazard warnings and instructions provided in the "Maintenance" section of this manual.

NOTE: The numbers in parentheses following individual parts indicate reference numbers on the Pump Parts List.

1. Drain and relieve pressure from the pump and system as required.
2. Starting on the **inboard** (driven) end of the pump, clean the pump shaft thoroughly, making sure the shaft is free of nicks and burrs. This will prevent damage to the mechanical seal when the inboard head assembly is removed.

3. Remove the inboard bearing cover capscrews (28) and slide the inboard bearing cover (27) and gasket (26) off the shaft. Discard the bearing cover gasket.

NOTE: On flange mounted pumps, a motor adaptor (108) takes the place of the inboard bearing cover. Remove the coupling (34) and the mounting screws (28A). The motor adaptor and gasket (26) can then be removed from the head (20).

4. Remove the outboard bearing cover capscrews (28) and slide the outboard bearing cover (27A) and gasket (26) off the shaft. Discard the bearing cover gasket.
5. To remove locknuts and lockwashers (24A and 24B):
  - a. Bend up the engaged lockwasher tang and rotate the locknut counterclockwise to remove it from the shaft
  - b. Slide the lockwasher (24B) off the shaft. Inspect the lockwasher for damage and replace as required.
  - c. Repeat steps a and b on the opposite shaft end.
6. Remove the head capscrews (21). **NOTE: It is a good practice to attach pump heads to the same ends they were removed from.**
7. Slide the head (20) off the shaft. The bearing (24), mechanical seal stationary seat and stationary O-ring (153A & 153D) will come off with the head assembly.
  - a. Pull the bearing (24) from the housing in the head.
  - b. To remove the mechanical seal stationary seat (153A), use the blunt end of a screw driver to gently push the backside of the stationary seat from the head. Place a cloth under the seal to avoid damage. Be careful not to contact the polished face of the seal during removal. Remove and discard mechanical seal stationary O-ring.
8. Carefully pull the rotating seal assembly, consisting of seal jacket (153C), rotating seal face and rotating O-ring (153B & 153E) from the shaft. Remove and discard the rotating O-ring (153E).
9. Carefully remove the disc (71) and head O-ring (72).
10. Pull the rotor and shaft (13) from the casing (12). While one hand is pulling the shaft, the other hand should be cupped underneath the rotor to prevent the vanes (14) from falling out. Carefully set the rotor and shaft (13) aside for future vane replacement and reassembly.
11. Lay the pump flat with the remaining head facing upward to remove the head assembly, mechanical seal, and disc from the outboard side of the pump, as instructed in steps 6 - 9 above.
12. If necessary, remove the liner (41) by tapping around the outside diameter of the liner with a hard wood drift and a hammer until it is driven from the casing (12).

## PARTS REPLACEMENT

1. If any of the O-rings have been removed or disturbed during disassembly, they be replaced with new O-rings.
2. Excessive or continuous leakage from the tell-tale hole in the bearing cover may be an indication of a damaged mechanical seal. If a mechanical seal has been leaking, it is recommended the entire seal be replaced. Refer to "General Pump Troubleshooting" for possible causes of seal leakage.

# MAINTENANCE

## PUMP ASSEMBLY

Before reassembling the pump, inspect all component parts for wear or damage, and replace as required. Wash out the bearing/seal recess of the head and remove any burrs or nicks from the rotor and shaft. Remove any burrs from the liner.

### Reassemble the OUTBOARD side of the pump first:

1. Align the liner keyway with the setscrew (74) that extends down into the pump casing (12) and start the liner (41) into the casing. The word "INTAKE" cast on the liner must face the intake port of the pump casing. Uniformly tap the outer edge of the liner with a rubber mallet to fully insert into the casing.
2. Place the disc (71) against the liner (41) with the seal cavity outward and disc relief hole located as shown in Figure 7.
3. Without installing the head O-ring (72) or mechanical seal components, temporarily attach the outboard head (20) and bearing (24) to the casing (12). Install and hand-tighten two head capscrews (21), 180 degrees apart. This head will be used to hold and align the rotor and shaft (13) while the inboard side of the pump is assembled. **NOTE: It is a good practice to attach pump heads to the same ends they were removed from.**
4. Before installing the rotor & shaft assembly (13), the direction of pump rotation must be determined as follows: If the pump is to be **right-hand** with **clockwise** rotation, the intake port and the relief valve must be on the **right** with the drive end of the shaft pointing towards the observer. If the pump is to be **left-hand** with **counterclockwise** rotation, the intake port and the relief valve must be on the **left** with the drive end of the shaft pointing towards the observer.
5. Remove the vanes (14) and push rods (77 - if equipped) from the rotor and shaft assembly (13). Inspect for wear and damage, and replace as follows:
  - a. Insert the vanes (14) into the bottom rotor slots with the relief grooves facing in the direction of pump rotation, and with the rounded edges outward. See Figure 6.

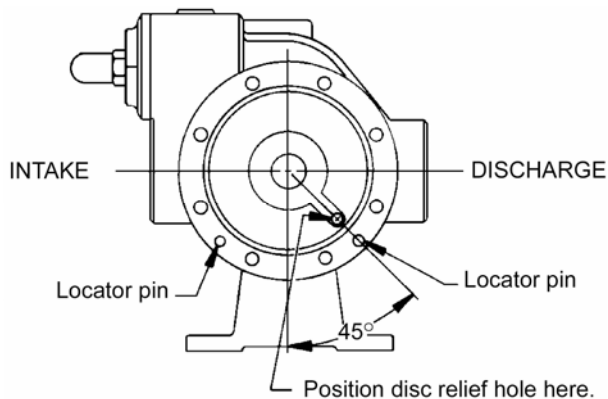

Figure 7 - Disc Relief Hole Location

- b. If the pump is equipped with the four-vane rotor and shaft (13A), hold the two bottom vanes (14) in place while inserting the two push rods (77).
  - c. After the bottom vanes (14) (and push rods, (77 - if equipped) are installed, carefully insert the non-driven end of rotor and shaft into the casing (12).
  - d. Install all remaining vanes (14) into the top positions of the rotor.
6. Install the disc (71) on the inboard side of the pump with the seal cavity facing outward and the disc relief hole located as shown in Figure 7.
  7. Install a new head O-ring (72) in the groove between the disc (71) and the casing(12).

## 8. MECHANICAL SEAL INSTALLATION

### Rotating Assembly –

- a. Apply a small amount of motor oil on the shaft between the shaft threads and the rotor.
- b. Slide the seal jacket assembly (153C) over the shaft and into the disc cavity with the drive tangs of the jacket towards the rotor. Rotate the jacket assembly to engage the drive tangs in the rotor slots.
- c. Install a new rotating O-ring (153E) in the rotating seal face (153B). Align and insert the rotating assembly into the the seal jacket with the polished face outward. Clean the polished face with a clean tissue and alcohol.

### Stationary Seat –

- d. Apply a small amount of motor oil in the seal recess of the head (20).
  - e. Install a new stationary O-ring (153D) in the stationary seat (153A). Clean the polished face with a clean tissue and alcohol. Align the pin in the stationary seat with the slot in the head recess and push the seat fully into the seal recess with the polished face outward.
9. Carefully install the inboard head assembly (20) over the shaft. Do not contact the end of the shaft with the polished face of the stationary seat. Center the head on the pump casing (12). Install and uniformly tighten four head capscrews (21) 90° apart; torque to 15 lbs ft (20.3 Nm). **NOTE: It is a good practice to attach pump heads to the same ends they were removed from.**
  10. Hand pack the ball bearing (24) with grease. Refer to the "Lubrication" section for the recommended grease.
  11. Install the bearing (24) into the head recess. The bearing balls should face outward, with the grease shield inward. The bearing must be fully and squarely seated in the head (20).
  12. Turn the pump casing around and remove the outboard head (20) previously installed.
  13. Install the outboard head (20), mechanical seal (153) and bearing (24) as instructed in steps 6 through 11.
  14. Rotate the shaft by hand to engage the mechanical seal drive tangs, and to test for binding or tight spots. If the rotor does not turn freely, lightly tap the rims of the heads (20) with a soft faced mallet until the correct position is found. Install all of the remaining head capscrews (21) for each head and uniformly torque to 15 lbs ft (20.3 Nm).



# MAINTENANCE

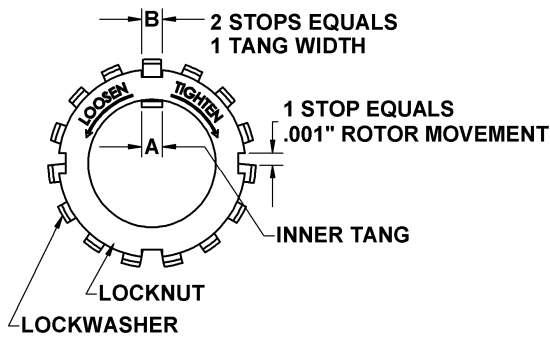

**Figure 8– Locknut Assembly**

## 15. LOCKNUT ADJUSTMENT

It is important that the bearing locknuts (24A) and lockwashers (24B) be installed and adjusted properly. Overtightening locknuts can cause bearing failure or a broken lockwasher tang. Loose locknuts will allow the rotor to shift against the discs (71), causing wear. See Figure 8.

- On both ends of the pump shaft, install a lockwasher (24B) with the tangs facing outward, followed by a locknut (24A) with the tapered end inward. Ensure the inner tang "A" of the lockwasher is located in the slot in the shaft threads, bending it slightly, if necessary.
  - Tighten both locknuts (24B) to ensure that the bearings (24) are bottomed in the head recess. **DO NOT** overtighten and bend or shear the lockwasher inner tang.
  - Loosen both locknuts (24A) one complete turn.
  - Tighten one locknut (24A) until a slight rotor drag is felt when turning the shaft by hand.
  - Back off the nut the width of one lockwasher tang "B". Secure the nut by bending the closest aligned lockwasher tang into the slot in the locknut. The pump should turn freely when rotated by hand.
  - Tighten the opposite locknut (24A) by hand until it is snug against the bearing (24). Then, using a spanner wrench, tighten the nut the width of one lockwasher tang "B". Tighten just past the desired tang, then back off the nut to align the tang with the locknut slot. Secure the nut by bending the aligned lockwasher tang into the slot in the locknut. The pump should continue to turn freely when rotated by hand.
  - To check adjustment, grasp the nut and washer with fingers and rotate back and forth. If this cannot be done, one or both locknuts are too tight and should be alternately loosened one stop at a time (.001" - 25 microns). Begin by loosening the locknut (24A) adjusted last.
16. Inspect the grease seal (104) for wear or damage and replace as required. Grease the outside diameter of the grease seal and push it into the inboard bearing cover (27) or motor adaptor (108) with the lip of the seal inward (towards the pump).

- Attach a new bearing cover gasket (26) and the inboard bearing cover (27) to the inboard head (20). Install the outboard bearing cover (27A) and a new gasket to the outboard head. Make sure the grease fittings (76) on the bearing covers are accessible. Install and torque the bearing cover capscrews (28) to 8 lbs ft (10.8 Nm).
  - On flange mounted pumps, the motor adaptor takes the place of the inboard bearing cover (27). To attach the motor adaptor to the head, install a new bearing cover gasket (26) and the four mounting screws (28A).
- ### 19. RELIEF VALVE ASSEMBLY
- Insert the valve (9) into the relief valve bore of the casing with the fluted end inward.
  - Install the relief valve spring (8) and spring guide (7) against the valve.
  - Attach a new relief valve O-ring (10) and the valve cover (4) on the cylinder.
  - Screw the relief valve adjusting screw (2) with locknut (3) into the valve cover (4) until it makes contact with the spring guide (7).
  - After the relief valve has been adjusted, tighten the Locknut (3) and install the relief valve cap (1) and O-ring (88)

### NOTICE:

**The relief valve setting MUST be tested and adjusted more precisely before putting the pump into service. Refer to "Relief Valve Setting and Adjustment"**

- Reinstall coupling, shaft key, and coupling guards.

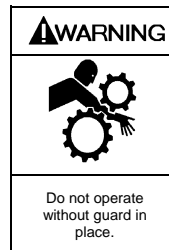

**Operation without guards in place can cause serious personal injury, major property damage, or death.**

- Refer to "Pre-Start Up Check List" and "Start Up Procedures" sections of this manual prior to restarting pump operation.

---

# TROUBLESHOOTING

## NOTICE:

Maintenance shall be performed by qualified technicians only,  
following the appropriate procedures and warnings as presented in this manual.

---

SYMPTOM	PROBABLE CAUSE
<b>Pump Not Priming</b>	<ol style="list-style-type: none"><li>1. Pump not wetted.</li><li>2. Worn vanes.</li><li>3. Internal control valve closed.</li><li>4. Strainer clogged.</li><li>5. Inlet line or valves clogged or too restrictive.</li><li>6. Broken drive train (truck mounted pumps).</li><li>7. Pump vapor-locked.</li><li>8. Pump speed too low for priming.</li><li>9. Relief valve partially open, worn or not seating properly.</li></ol>
<b>Reduced Capacity</b>	<ol style="list-style-type: none"><li>1. Pump speed too low.</li><li>2. Internal control valve not fully open.</li><li>3. Excessive restriction in the inlet line (i.e.: undersized piping, too many elbows &amp; fittings, clogged strainer, etc.).</li><li>4. Damaged or worn parts (vanes, discs, liner or rotor).</li><li>5. Excessive restriction in discharge line causing partial flow through the relief valve.</li><li>6. Relief Valve worn, set too low, or not seating properly.</li><li>7. External Bypass Valve set too low.</li><li>8. Operating without a vapor return line.</li><li>9. Vanes installed incorrectly (see "Vane Replacement").</li><li>10. Liner installed backwards</li></ol>
<b>Noise</b>	<ol style="list-style-type: none"><li>1. Excessive pressure drop on the pump due to:<ol style="list-style-type: none"><li>a. Undersized or restricted fittings in the inlet line.</li><li>b. Pump speed too fast.</li><li>c. Pump too far from fluid source.</li></ol></li><li>2. Running the pump for extended periods with a closed discharge line.</li><li>3. Pump not securely mounted.</li><li>4. Misalignment of pump, reducer or motor - base mounted pumps.</li><li>5. Bearings worn or damaged.</li><li>6. Vibration from improperly anchored piping.</li><li>7. Bent shaft, or drive coupling misaligned.</li><li>8. Excessively worn rotor.</li><li>9. Malfunctioning valve in the system.</li><li>10. Relief valve setting too low.</li><li>11. Liner installed backwards.</li><li>12. Damaged vanes (see following category).</li></ol>
<b>Damaged Vanes</b>	<ol style="list-style-type: none"><li>1. Foreign objects entering the pump.</li><li>2. Running the pump dry for extended periods of time.</li><li>3. Cavitation.</li><li>4. Excessive heat.</li><li>5. Worn or bent push rods, or worn push rod holes (4-vane rotors only).</li><li>6. Hydraulic hammer - pressure spikes.</li><li>7. Vanes installed incorrectly (see "Vane Replacement").</li><li>8. Incompatibility with the liquids pumped.</li></ol>
<b>Broken Shaft</b>	<ol style="list-style-type: none"><li>1. Foreign objects entering the pump.</li><li>2. Relief valve not opening.</li><li>3. Hydraulic hammer - pressure spikes.</li><li>4. Pump/driver, driveline/drive shaft misalignment.</li><li>5. Excessively worn vanes or vane slots.</li></ol>
<b>Mechanical Seal Leakage</b>	<ol style="list-style-type: none"><li>1. O-rings not compatible with the liquids pumped.</li><li>2. O-rings nicked, cut or twisted.</li><li>3. Shaft at seal area damaged, worn or dirty.</li><li>4. Ball bearings overgreased.</li><li>5. Excessive cavitation.</li><li>6. Mechanical seal faces cracked, scratched, pitted or dirty.</li></ol>
<b>Overload on Motor</b>	<ol style="list-style-type: none"><li>1. Motor Horsepower not sufficient for application.</li><li>2. Improper wiring and/or low voltage to motor.</li><li>3. Misalignment</li><li>4. Excessive pressure or speed.</li><li>5. Bearing locknuts adjusted improperly.</li><li>6. Faulty or worn bearings.</li><li>7. Rotor rubbing against head or cylinder.</li><li>8. Dirty mechanical seal faces.</li></ol>

---

---

**NOTES**

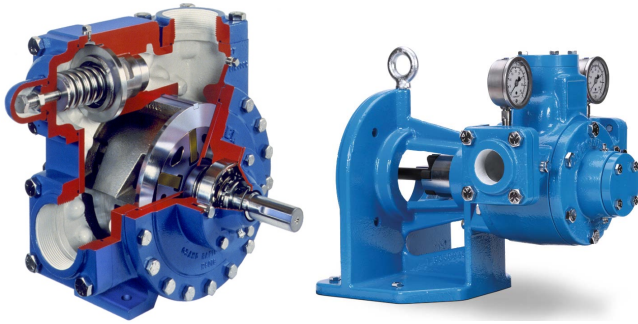

Sliding Vane Pumps: 5 to 2200 GPM  
Refined Fuels, Liquefied Gases, Solvents, Process



Stainless Steel Sliding Vane Pumps  
1 to 265 GPM: Acids, Brines, Sugars, Syrups,  
Beer, Beet Juice, Cider, Flavor Extracts, etc.

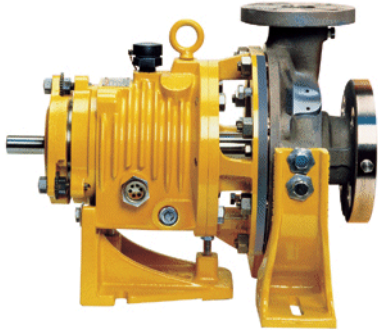

System One® Centrifugal Pumps  
10 to 7500 GPM; Process, Marine



Magnetic Drive Pumps  
Stainless Steel: 14 to 215 GPM

HXL 6, 8 & 10"  
Sliding Vane Pumps  
130 to 2,220 GPM

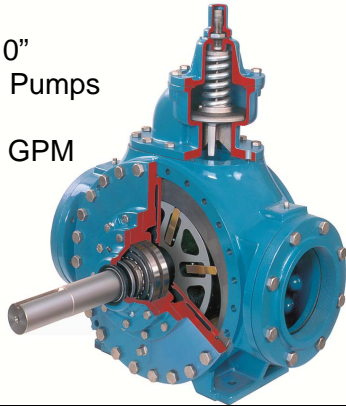

Refineries  
Terminals  
Barges  
Ships



Reciprocating Gas Compressors  
Liquefied Gas Transfer, Boosting, Vapor Recovery



Hand Operated Pumps  
Dispensing, Transfer, In-line



Accessories  
Gear Reducers, Bypass Valves, Strainers

Visit [www.blackmer.com](http://www.blackmer.com) for complete information on all Blackmer products



1809 Century Avenue, Grand Rapids, Michigan 49503-1530 U.S.A.  
Telephone: (616) 241-1611 • Fax: (616) 241-3752

E-mail: [blackmer@blackmer.com](mailto:blackmer@blackmer.com) • Internet Address: [www.blackmer.com](http://www.blackmer.com)