

Pole Basics

January, 2008

Table of Contents

| | |
|----------------------------|--------|
| Available Poles | Page 2 |
| Bolt-on Brackets | Page 3 |
| Tenon Mount Brackets | Page 4 |
| Internal Slipfitter | Page 5 |
| Handhole Covers | Page 5 |
| Pole Caps | Page 5 |
| Anchor Bolts | Page 6 |
| Base Covers | Page 7 |
| EPAs | Page 8 |
| Wall Mount Brackets | Page 8 |



A Company with a *Smart Vision*

● STEEL ROUND POLES

■ STEEL SQUARE POLES

◎ STEEL ROUND TAPERED POLES

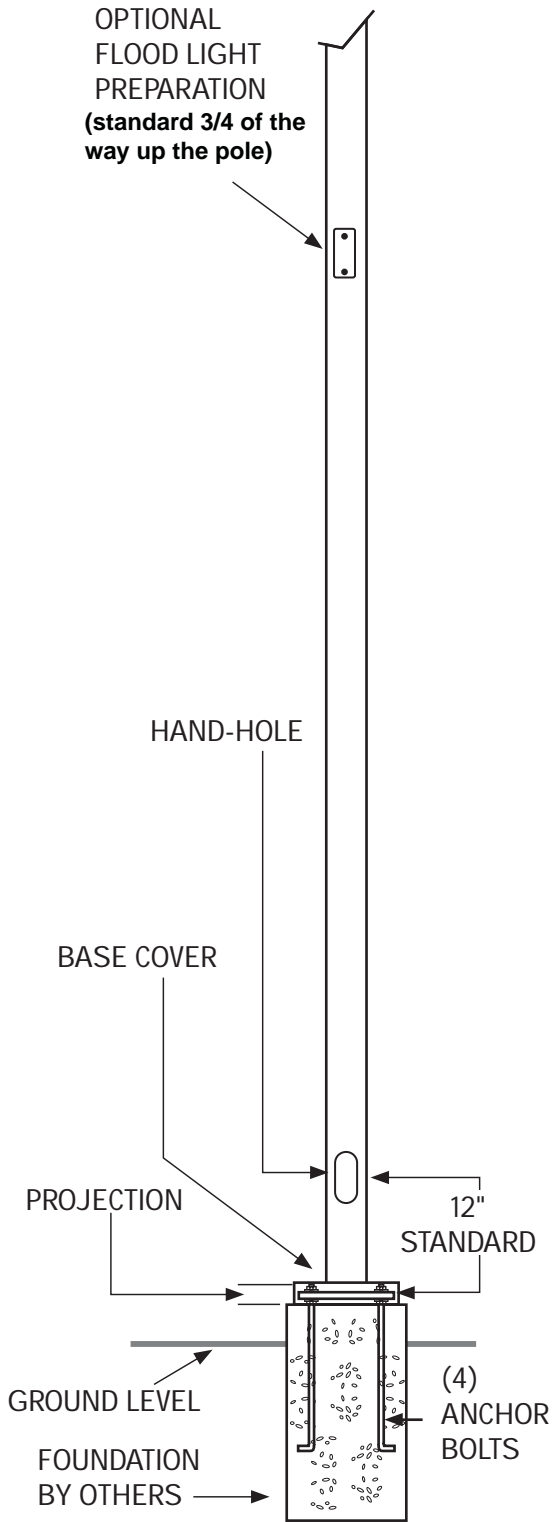

OPTIONAL
FLOOD LIGHT
PREPARATION
(standard 3/4 of the
way up the pole)

Standard Drill 2-Bolt Pattern
(2 mounting holes - 1 wireway)

SQBO
RPBO
RTPBO

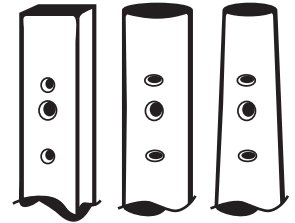

Tenon Mount

SQN
RPN
RTPN
Standard Tennon
2 3/8" dia. x 4 3/4" Tall

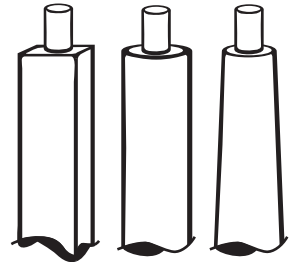

Pole Top Mount

SQP
RPP
RTPP

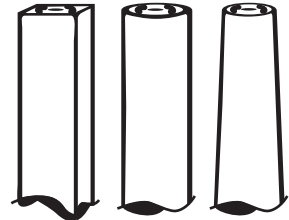

Top View



No Drilling
SQI

For use with
Internal Slip-Fitter
Bracket (See p.5)



Flood Light Preparation
Available on all Above Poles

For use with
FBO Brackets
(See p.3)

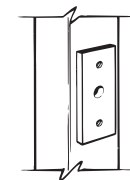

Square Poles

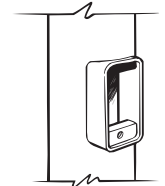

Round and Round
Tapered Poles

SQBO, RPBO, RTPBO (2-bolt pattern)



2-1/2" x 5-3/8" x 6"
2-1/2" x 5-3/8" x 8"
2-1/2" x 5-3/8" x 12"

BKA BO S (6, 8, or 12) CLR R

Aluminum 2-bolt pattern-
Use with all area light fixtures
except Challenger, Patriot or Patriot Small.
(Round pole applications use RPP2)
6" Part # 16196601CLR
8" Part # 16196604CLR
12" Part # 16196602CLR

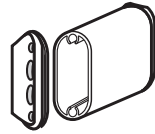

2-1/2" x 5-3/8" x 6"

BKA HRBO S 6 CLR

Aluminum 2-bolt pattern-
Use with Hilton II & Hilton II Small
on round poles.
Part # 168414CLR

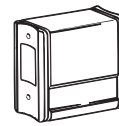

2-1/2" x 6-7/8" x 6"

BKA HIBO S 6 CLR

Aluminum 2-bolt pattern-
Use with Hilton Large on round poles.
Part # 43050CLR

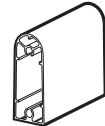

BKA BO EC 6 CLR

Aluminum extension bracket-
Use with Challenger or Patriot.
Part # 142862CLR
For Patriot Small,
order BKA-BO-PTS-EC6-CLR
Part # 263228CLR
(Round pole applications require RPPC)

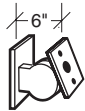

BKA BO ADJ 6 CLR - Adjustable

Aluminum 2-bolt pattern (both sides)-
Standard arm is not used.
Cannot be used with top-access fixtures,
Hilton Large, Challenger, Patriot or
Patriot Small. For use with square pole
only.
Part # 130526CLR

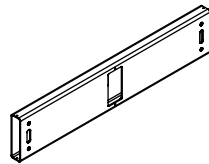

BKS BO PA 40 CLR - Parallel Arm

1 piece steel 2-bolt pattern designed for
direct mounting of fixture to face of bracket.
Standard arms are not required except for
Hilton Series.
Part # 141028CLR

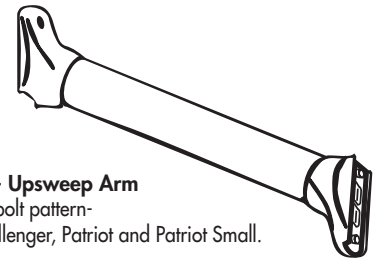

BKU BO S 19 CLR - Upsweep Arm

3 piece aluminum 2-bolt pattern-
Compatible with Challenger, Patriot and Patriot Small.
Part # 144191CLR



RPP2 BLK - Round Pole Plate
Part # 162914BLK



RPPC CLR - Round Pole Plate
For Challenger, Patriot and Patriot Small
Part # 141940CLR



BKA BO RA 8 CLR - Radius Arm

For Challenger, Challenger Medium, Patriot, Patriot Small,
all Square and Rectangular Fixtures
Part # 169010 CLR

Drilling Locations

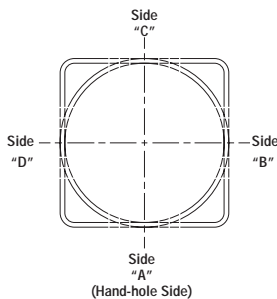

| | Sides | | | |
|----------------|-------|---|---|---|
| | A | B | C | D |
| Hand-hole | X | | | |
| Single | X | | | |
| D180° | | X | | X |
| D90° | X | | | X |
| T90° | X | X | | X |
| TN120°* | X | | | |
| Q90° | X | X | X | X |
| Single FBO(SF) | X | | | |
| Double FBO(DF) | | X | | X |

Note: Consult factory for custom variations. Standard SF and DF pole preparations are located 3/4 of the height of the pole from the base, unless otherwise specified. (Except on 20' Round Tapered pole -Maximum height for SF & DF is 13' from base.)

*Other two locations will be 120° to the left and right of Side A.

Fixture Configurations

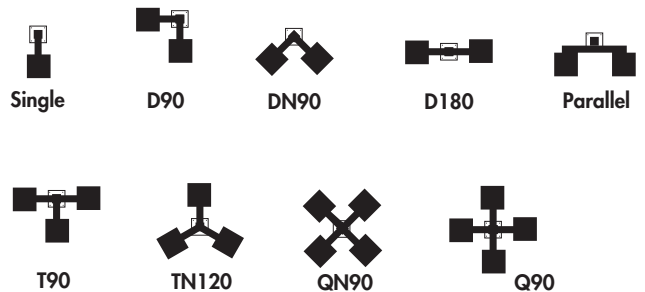

Flood Brackets - For use with SF & DF pole preparations

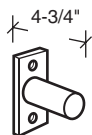

BKS FBO 5 * CLR
Part # 107054CLR

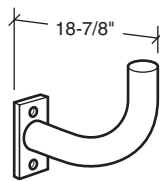

BKS FBO 18 * CLR
Part # 107053CLR

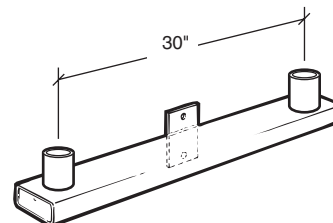

BKS FBO 30 CLR
Part # 133163CLR



SQN, RPN, RTPN

Tenon Mount Fitters



Single/D180 (drilled 2 sides)
D90/Q90/T90 (drilled 4 sides)

BAK NM * CLR

For flat surface brackets.

Single/D180 - **Part # 43549CLR**
D90/Q90/T90 - **Part # 43548CLR**

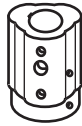

BAK RNM TN120 * CLR

Drilled 3 sides at 120°. For radius surface brackets. Round pole plate is required for use with all fixtures except Hilton Series.

Part # 107023CLR

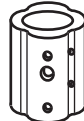

BAK RNM Q90 * CLR

Drilled 4 sides at 90°. For radius surface brackets. Round pole plate is required for use with all fixtures except Hilton Series.

Part # 107028CLR



BAK NM MA 5 CLR Mast Arm Adaptor

For use with existing mast arm by others. Cannot be used with Hilton Series. Slipfits 2" pipe (2-3/8" O.D.)

Part # 168778CLR

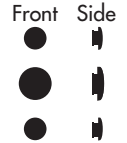

Mounting Hole Plugs Set of 3 for square pole.

Part # 132336
MHD mounting hole decal is available for round poles. Consult factory.

Tenon Mount Adjustable

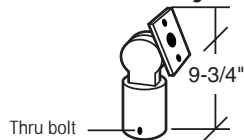

BAK NM ADJ * CLR

Aluminum round slipfitter for 2-3/8" O.D. or 2-7/8" O.D. tenon - should not be used with standard arm. Cannot be used with top-access fixtures, Challenger, Patriot, Hilton Large or Patriot Small Series.

Part No. - 130527CLR

Tenon Mount Parallel Arm

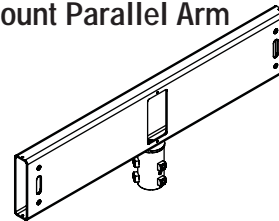

2" x 8" x 40"
Tenon Adaptor

BKS NM PA 40 CLR

One piece steel arm, round slipfitter for 2 3/8" O.D. tenon. Designed for direct mounting of fixtures to face of bracket. Standard arm is not required, except for Hilton Series.

Part No. - 143888CLR

Tenon Reducers

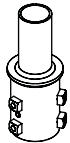

NM-RD

Steel round slipfitter reducer, comes with set screws and one through bolt.

Pole Top Adaptors



RPT-TA

Steel round slipfitter reducer, comes with set screws and one through bolt.

| P/N | Description | I.D. | O.D. | Fits | How Much Play |
|-----------|-------------------|--------|------|-------------|------------------|
| 137096CLR | BKS-NM-RD-2.5-CLR | 3.068" | 3.5" | 2.875" O.D. | 2-5/8" to 2-7/8" |
| 137093CLR | BKS-NM-RD-3.0-CLR | 3.640" | 4.0" | 3.5" O.D. | 3-1/4" to 3-1/2" |
| 137090CLR | BKS-NM-RD-3.5-CLR | 4.140" | 4.5" | 4.0" O.D. | 3-3/4" to 4" |

| P/N | Description | I.D. | O.D. | Fits | How Much Play |
|-----------|--------------------|--------|--------|-------------|------------------|
| 107073CLR | BKS-RPT-TA-2-CLR | 2.469" | 2.875" | 2.375" O.D. | 1-7/8" to 2-3/8" |
| 107074CLR | BKS-RPT-TA-2.5-CLR | 3.068" | 3.5" | 2.875" O.D. | 2-5/8" to 2-7/8" |
| 107075CLR | BKS-RPT-TA-3-CLR | 3.548" | 4.0" | 3.5" O.D. | 3-1/4" to 3-1/2" |

NOTES:

Part description refers to pipe size. Our standard tenon is 2-3/8" dia. x 4-3/4" high.

I.D. = Inside diameter of the reducer/pole adaptor.
O.D. = Outside diameter of the reducer.

How Much Play = For the in between sizes of their tenon, you have about 1/4" play.
Fits = Customer's existing tenon size.

Flood Brackets - Used with tenon mount poles

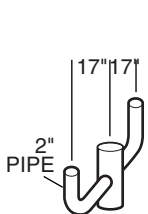

BKS-PTB-2-CLR
Part# 107066CLR

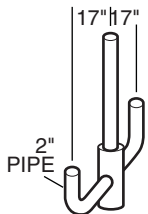

BKS-PTB-3-CLR
Part# 107070CLR

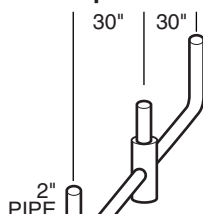

BKS-PTB-3-30-CLR
Part# 133505CLR

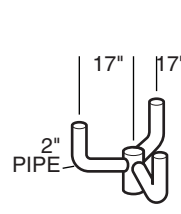

BKS-PTB-3-120-CLR
Part# 107067CLR

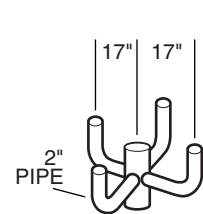

BKS-PTB-4-CLR
Part# 123109CLR



BKS-PTB-12-CLR
Part# 137105CLR



BKS-PTB-13-CLR
Part# 137106CLR

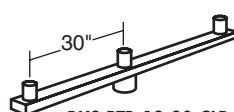

BKS-PTB-13-30-CLR
Part# 137107CLR

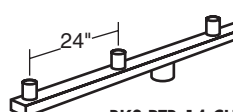

BKS-PTB-14-CLR
Part# 137108CLR



BKS-PTB-15-CLR
Part# 137109CLR

SQL (no drilling)

Internal Slip Fitter Bracket

U.S. Patent # 5,599,094
 BKA (4ISF, 5ISF) (Q90, D180) CLR

Utilize to retrofit existing 4" & 5" square poles.
 Use with 4" or 5" SQL poles with wall thickness of 11 ga. (0.120) or 7 ga. (0.180).
 D180 slipfitters come with (1) set of plugs
 Q90 slipfitters come with (2) sets of plugs
 * Do not use on round tapered or round poles

BKA 4ISF D180 * CLR PART# 122625CLR
 BKA 4ISF Q90 * CLR PART# 122626CLR
 BKA 5ISF D180 * CLR PART# 122627CLR
 BKA 5ISF Q90 * CLR PART# 122628CLR

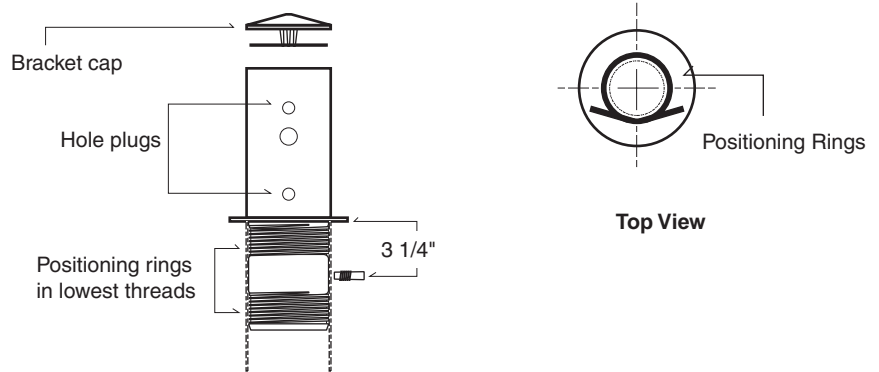

Handhole Covers

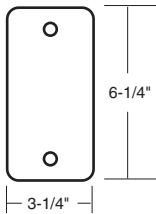

Part #53919CLR
 Used on all square steel poles and all round steel poles 18'-0" and above except Round Tapered Steel.

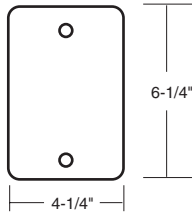

Part #53911CLR
 Used on all Round Tapered Steel Poles.

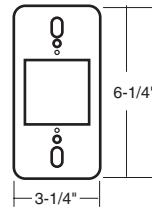

Part #53306CLR
 Used on all ER2 & GFI options for all Square Steel Poles, and all Round Steel Poles 18'-0" and above except Round Tapered Steel. No receptacle.

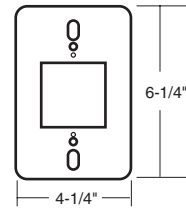

Part #53928CLR
 Used on all ER2 & GFI options for Round Tapered Steel Poles. No receptacle.

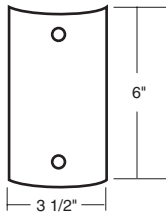

Part #53458CLR
 Used on all 4" & 5" Round Steel Poles under 18'-0"

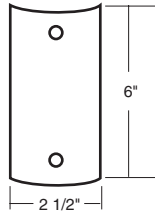

Part #158152CLR
 Used on all SMC & SMT Doral Brackets

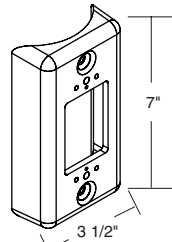

Part #5707502CLR
 Used on all ER2 & GFI options for 4" & 5" Round Steel Poles under 18'-0". No receptacle.

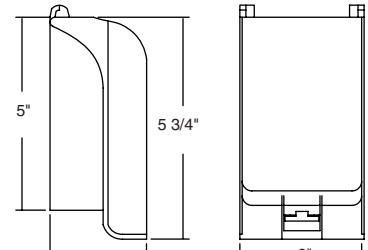

Part #179079
 In use cover. Used on all ER2 & GFI options

Pole Caps



ROUND TAPERED
 3" 20/25 ft. Part #54018
 3-1/4" 30/50 ft. Part #54019
 3-1/2" 35/39 ft. Part #54020
 4" 45 ft. Part #54015



ROUND
 4" Part #54015
 5" Part #54016



SQUARE
 4" Part #54008
 5" Part #54009
 6" Part #54010

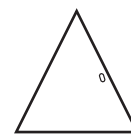

BOLT-ON TN120 for square pole
 4" Part #132029CLR
 5" Part #132030CLR

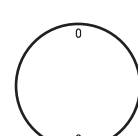

TENON FITTER (BKA RNM)
 Part #53460CLR

3/8" x 10" GALV. STEEL

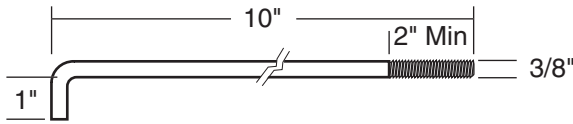

Used with: AB kit# 285560 Bollards 4 1/2" BOLT CIRCLE.

Each anchor bolt furnished with:

(2) 3/8"-16 zinc plated hex nuts and

(2) U.S.S. 3/8" flat washers (7/16" I.D. x 1" O.D. x 5/64" thick) zinc plated

3/4" x 30" STEEL / 3/4" x 30" GALVANIZED (FULLY)

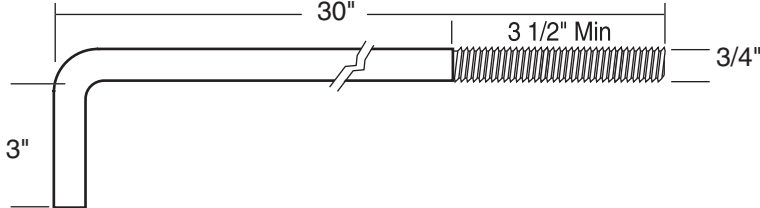

Steel used with:

AB kit# 122584 4SQ STL. S11G/S07G 8-11" BOLT CIRCLE

AB kit# 122582 4RP STL. S10G 11" BOLT CIRCLE

AB kit# 1225850 5SQ STL. S11G 11" BOLT CIRCLE

AB kit# 135460 5RP STL. S11G 11" BOLT CIRCLE

Galvanized used with:

AB kit# 122609 4SQ STL. GAL S11G/S07G 8-11" BOLT CIRCLE

AB kit# 122607 4RP STL. GAL S10G 11" BOLT CIRCLE

AB kit# 122610 5SQ STL. GAL S11G 11" BOLT CIRCLE

AB kit# 135461 5RP STL. GAL S11G 11" BOLT CIRCLE

Each anchor bolt furnished with:

(2) 3/4"-10 zinc plated or galvanized hex nuts and

(2) U.S.S. 3/4" flat washers (13/16" I.D. x 2" O.D. x 5/32" thick) zinc plated or galvanized

1" x 36" STEEL / 1" x 36" GALVANIZED (PARTIALLY)

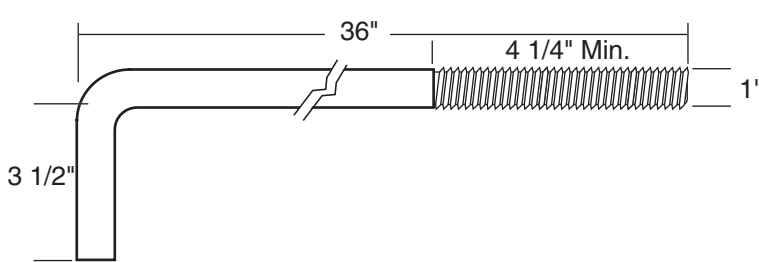

Steel used with:

AB kit# 122586 5SQ STL. S11H/S07G 11" BOLT CIRCLE

AB kit# 122583 5RP STL. S07G 11" BOLT CIRCLE

AB kit# 122587 6SQ STL. S07G 12" BOLT CIRCLE

AB kit# 122588 RTP STL. 20/25/30' S11G 11" BOLT CIRCLE

AB kit# 122589 RTP STL. 35/39' S11G 12" BOLT CIRCLE

Galvanized used with:

AB kit# 122611 5SQ STL. GAL S11H/S07G 11" BOLT CIRCLE

AB kit# 122608 5RP STL. GAL S07G 11" BOLT CIRCLE

AB kit# 122612 6SQ STL. GAL S07G 12" BOLT CIRCLE

AB kit# 122613 RTP STL. GAL S11G 20/25/30' 11" BOLT CIRCLE

AB kit# 122614 RTP STL. GAL S11G 35/39' 12" BOLT CIRCLE

Each anchor bolt furnished with:

(2) 1"-8 zinc plated or galvanized hex nuts and

(2) U.S.S. 1" flat washers (1 1/16" I.D. x 2 1/2" O.D. x 11/64" thick) zinc plated or galvanized

1-1/4" x 42" STEEL / 1-1/4" x 42" GALVANIZED (PARTIALLY)

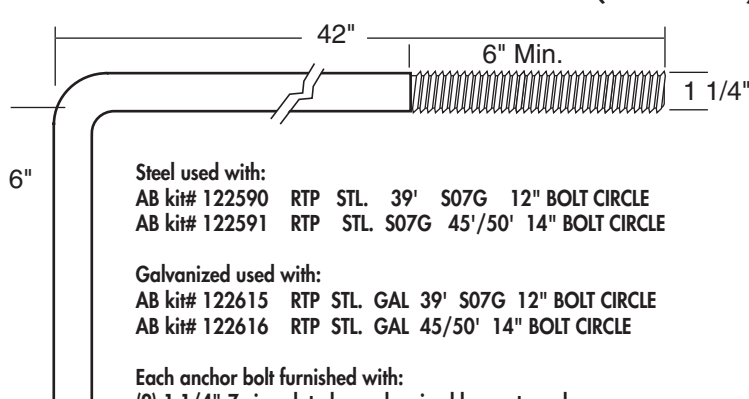

Steel used with:

AB kit# 122590 RTP STL. 39' S07G 12" BOLT CIRCLE

AB kit# 122591 RTP STL. S07G 45'/50' 14" BOLT CIRCLE

Galvanized used with:

AB kit# 122615 RTP STL. GAL 39' S07G 12" BOLT CIRCLE

AB kit# 122616 RTP STL. GAL 45'/50' 14" BOLT CIRCLE

Each anchor bolt furnished with:

(2) 1 1/4"-7 zinc plated or galvanized hex nuts and

(2) U.S.S. 1 1/4" flat washers (1 3/8" I.D. x 3" O.D. x .165" thick) zinc plated or galvanized

Anchor Bolt Conversion Table

| "A" Bolt Square | = | "B" Bolt Circle |
|--------------------|---|--------------------|
| 3.19" | | 4.50" |
| 4.50 | | 6.36 |
| 5.00 | | 7.00 |
| 5.66 | | 8.00 |
| 6.50 | | 9.19 |
| 6.75 | | 9.50 |
| 7.75 | | 11.00 |
| 8.12 | | 11.50 |
| 8.50 | | 12.00 |
| 8.84 | | 12.50 |
| 9.19 | | 13.00 |
| 9.90 | | 14.00 |
| 10.25 | | 14.50 |
| 12.00 | | 17.00 |

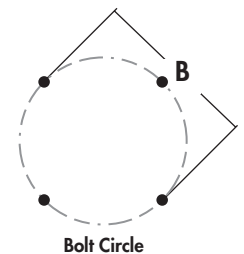
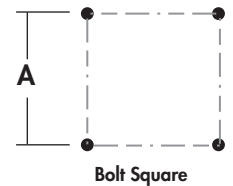

Base Covers

11.318" Square

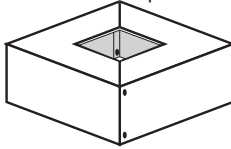

SQUARE STEEL POLES

4"BC
4.3" tall with 4.125" sq. opening
Part #122559CLR

5"BC
4.8" tall with 5.125" sq. opening
Part #122561CLR

6"BC
5" tall with 6.125" sq. opening
Part #122563CLR

11.318" Square

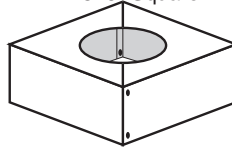

ROUND STEEL POLES

4"SRBC
4.3" tall with 4.125" dia. opening
Part #158450CLR

5"SRBC
4.8" tall with 5.125" dia. opening
Part #158451CLR

11.318" - 14.5" Square

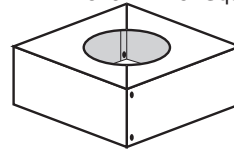

ROUND TAPERED STEEL POLES

20' SRTBC
11.318" sq. x 4.8" tall with 6.15" dia. opening
Part #158388CLR

25' SRTBC
11.318" sq. x 4.8" tall with 6.85" dia. opening
Part #158390CLR

30' SRTBC
11.318" sq. x 4.8" tall with 7.75" dia. opening
Part #158392CLR

35' SRTBC
13" sq. x 4.875" tall with 8.75" dia. opening
Part #158554CLR

39' SRTBC
12.875" sq. x 5.5" tall with 9.25" dia. opening
Part #155887CLR(7 & 11 GAUGE)

45' SRTBC
14.5" sq. x 5.875" tall with 10.25" dia. opening
Part #158571CLR

50' SRTBC
14.5" sq. x 5.875" tall with 10.25" dia. opening
Part #158578CLR

Pole EPAs

| Height | EPA* | | | | Outside Dimensions | Material | Bolt Circle |
|----------------------------------|--------|--------|--------|---------|--------------------|----------|-------------|
| | 70 MPH | 80 MPH | 90 MPH | 100 MPH | | | |
| STEEL SQUARE POLES | | | | | | | |
| 14' | 23.3 | 16.7 | 12.2 | 9.0 | 4" | S11G | B |
| 16' | 18.6 | 13.1 | 9.3 | 6.5 | 4" | S11G | B |
| 16' | 34.6 | 25.0 | 18.5 | 13.8 | 5" | S11G | C |
| 18' | 14.4 | 9.7 | 6.5 | 4.2 | 4" | S11G | B |
| 18' | 27.9 | 19.7 | 14.1 | 10.1 | 5" | S11G | C |
| 20' | 11.0 | 7.0 | 4.2 | 2.2 | 4" | S11G | B |
| 20' | 18.7 | 12.8 | 8.8 | 5.9 | 4" | S07G | B |
| 20' | 22.5 | 15.4 | 10.5 | 7.0 | 5" | S11G | C |
| 20' | 35.5 | 25.4 | 18.4 | 13.4 | 5" | S07G | D |
| 22' | 10.4 | 6.3 | 3.4 | 1.4 | 4" | S11G | B |
| 22' | 18.7 | 12.6 | 8.4 | 5.4 | 4" | S07G | B |
| 22' | 20.8 | 13.8 | 8.9 | 5.5 | 5" | S11G | C |
| 22' | 34.0 | 23.9 | 17.0 | 12.0 | 5" | S07G | D |
| 24' | 7.7 | 4.0 | 1.5 | — | 4" | S11G | B |
| 24' | 15.1 | 9.7 | 6.0 | 3.3 | 4" | S11G | B |
| 24' | 16.7 | 10.5 | 6.2 | 3.1 | 5" | S11G | C |
| 24' | 28.6 | 19.6 | 13.4 | 8.9 | 5" | S07G | D |
| 24' | 46.2 | 32.6 | 23.2 | 16.6 | 6" | S07G | J |
| 26' | 5.3 | 2.1 | — | — | 4" | S11G | B |
| 26' | 12.0 | 7.2 | 3.9 | 1.5 | 4" | S07G | B |
| 26' | 13.2 | 7.6 | 3.8 | 1.0 | 5" | S11G | C |
| 26' | 24.0 | 15.8 | 10.3 | 6.3 | 5" | S07G | D |
| 26' | 39.6 | 27.3 | 18.9 | 12.9 | 6" | S07G | J |
| 28' | 19.9 | 12.5 | 7.5 | 3.9 | 5" | S07G | D |
| 28' | 33.9 | 22.7 | 15.1 | 9.6 | 6" | S07G | J |
| 30' | 16.3 | 9.6 | 5.0 | 1.7 | 5" | S07G | D |
| 30' | 28.8 | 18.6 | 11.6 | 6.6 | 6" | S07G | J |
| 35' | 18.3 | 10.0 | 4.3 | — | 6" | S07G | J |
| 39' | 11.5 | 4.3 | — | — | 6" | S07G | J |
| ROUND TAPERED STEEL POLES | | | | | | | |
| 20' | 33.6 | 24.8 | 18.8 | 14.4 | S11 Ga. | N | |
| 25' | 31.4 | 22.9 | 17.0 | 12.8 | S11 Ga. | N | |
| 30' | 30.7 | 22.0 | 16.0 | 11.7 | S11 Ga. | N | |
| 35' | 30.1 | 21.1 | 14.9 | 10.5 | S11 Ga. | O | |
| 39' | 27.1 | 18.5 | 12.6 | 8.4 | S11 Ga. | O | |
| 39' | 51.1 | 36.9 | 27.1 | 20.2 | S07 Ga. | S | |
| 45'* | 42.3 | 31.4 | 24.0 | 18.6 | S07 Ga. | T | |
| 50'* | 28.9 | 21.0 | 15.6 | 11.7 | S07 Ga. | T | |
| STEEL ROUND POLES | | | | | | | |
| 18' | 15.5 | 11.1 | 8.0 | 5.8 | 4" | S10G | L |
| 20' | 12.5 | 8.7 | 6.1 | 4.2 | 4" | S10G | L |
| 20' | 20.0 | 14.2 | 10.2 | 7.4 | 5" | S11G | L |
| 22' | 10.0 | 6.7 | 4.4 | 2.8 | 4" | S10G | L |
| 22' | 16.6 | 11.5 | 8.0 | 5.5 | 5" | S11G | L |
| 24' | 7.8 | 4.9 | 3.0 | 1.5 | 4" | S10G | L |
| 24' | 13.6 | 9.1 | 6.0 | 3.8 | 5" | S11G | L |
| 24' | 22.9 | 16.2 | 11.6 | 8.3 | 5" | S07G | M |
| 26' | 11.1 | 7.1 | 4.3 | 2.3 | 5" | S11G | L |
| 26' | 19.5 | 13.5 | 9.4 | 6.4 | 5" | S07G | M |
| 28' | 16.5 | 11.1 | 7.4 | 4.7 | 5" | S07G | M |
| 30' | 13.8 | 8.9 | 5.6 | 3.2 | 5" | S07G | M |

BOLT CIRCLES

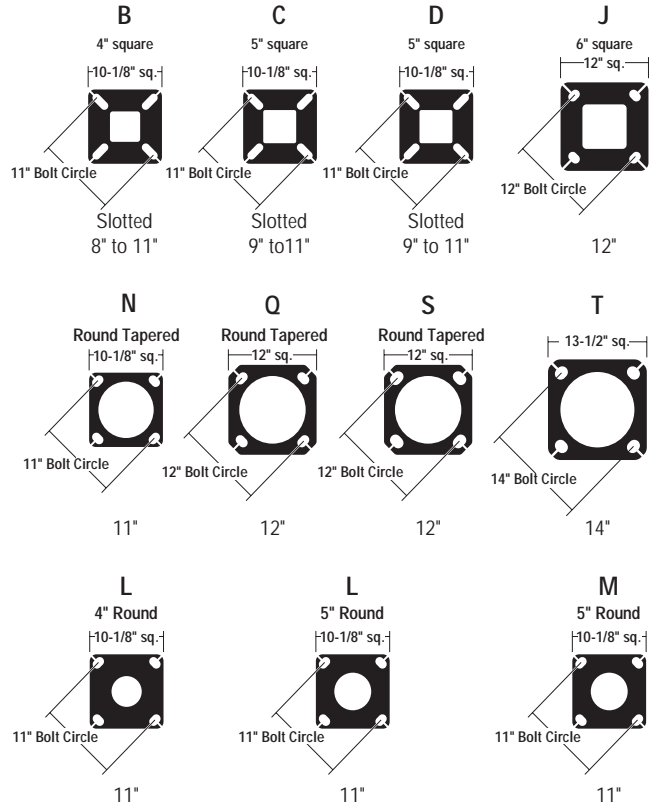

* All LSI Lighting Systems' poles are guaranteed to meet the EPA requirements listed. LSI Lighting Systems is not responsible if a pole order has a lower EPA rating than the indicated wind-loading zone where the pole will be located. **Caution:** This guarantee does not apply if the pole/bracket/fixture combination is used to support any other items such as flags, pennants, or signs, which would add stress to the pole. LSI Lighting Systems cannot accept responsibility for harm or damage caused in these situations. **Note:** Pole calculations include a 1.3 gust factor over steady wind velocity. Example: poles designed to withstand 80 MPH steady wind will withstand gusts to 104 MPH. EPAs are for locations 100 miles away from hurricane ocean lines. **Note:** Hurricane ocean lines are the Atlantic and Gulf of Mexico coastal areas. For applications in Florida or Canada, consult factory.

** 45' and 50' poles are two-piece; bottom is S07G and top is S11G.

If luminaire total weight exceeds 250 lbs., consult factory.

Wall Mount Brackets

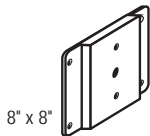

BKS BO WM * CLR
Steel 2-bolt pattern Wall Mount Plate for flat surfaced arm.
Part# 123111CLR
For Patriot Small use
BKS-BO-PTS-WM-* CLR
Part# 263230CLR



BKA RBO WM * CLR
Aluminum 2-bolt pattern Wall Mount Plate - radiused arm for use with round fixtures.
Part# 123113CLR



BKA WM ADJ 6 CLR
Adjustable aluminum 2-bolt pattern. Standard fixture arm is not used. Cannot be used with top-access fixtures, Challenger, Patriot, Hilton Large or Patriot Small fixtures.
Part# 130519CLR



A Company with a Smart Vision

LSI INDUSTRIES INC.
10000 Alliance Road
Cincinnati, Ohio 45242
(513)793-3200 FAX (513)984-9723
www.lsi-industries.com